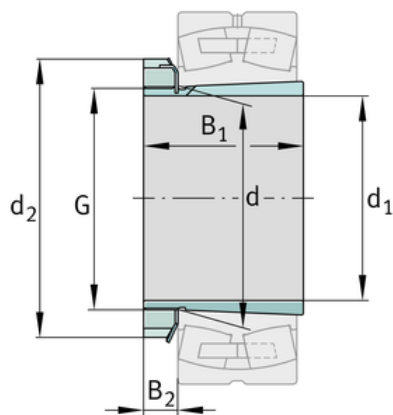
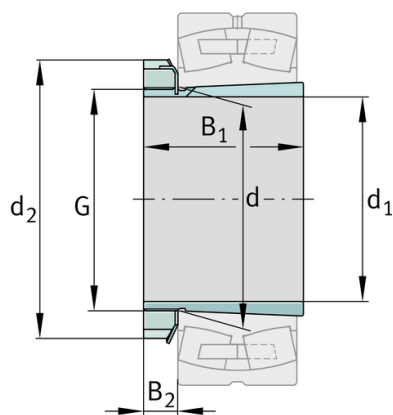
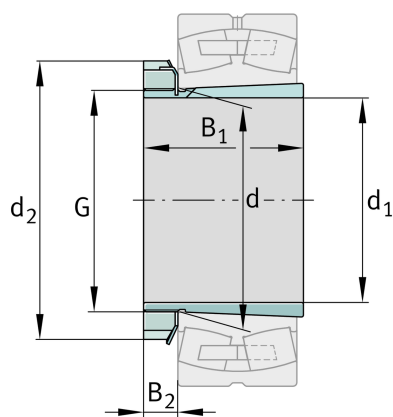
**FAG**★ **H207**

## Adapter sleeve

Schaeffler ID:  
0167305500000Adapter sleeve H, accessory rolling  
bearing, complete, mechanical, FP

★ Preferred product

## Technical information

**Main Dimensions & Performance Data**

$d_1$	30 mm	bore diameter
G	M35x1,5	Thread
$B_1$	29 mm	sleeve length
	0,142 kg	Weight

**Dimensions**

d	35 mm	Bore diameter bearing
$d_2$	52 mm	Outside diameter nut
$B_2$	9,25 mm	Width nut and lock

**Additional information**

	KM7	Locknut
	MB7	Fuse
	1:12	Taper

