



FAG

★ **H211**

Adapter sleeve

Schaeffler ID:
0167306070000

Adapter sleeve H, accessory rolling bearing, complete, mechanical, FP

★ Preferred product

Technical information

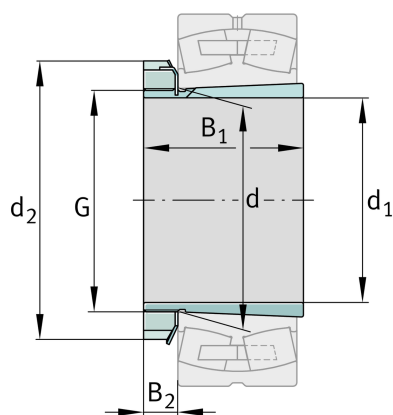

Main Dimensions & Performance Data

d_1	50 mm	bore diameter
G	M55x2	Thread
B_1	37 mm	sleeve length
	0,16 kg	Weight

Dimensions

d	55 mm	Bore diameter bearing
d_2	75 mm	Outside diameter nut
B_2	12,5 mm	Width nut and lock

Additional information

	KM11	Locknut
	MB11	Fuse
	1:12	Taper

