

FAG

★ **H213**

Adapter sleeve

Schaeffler ID:
0167306230000

Adapter sleeve H, accessory rolling bearing, complete, mechanical, FP

★ Preferred product

Technical information

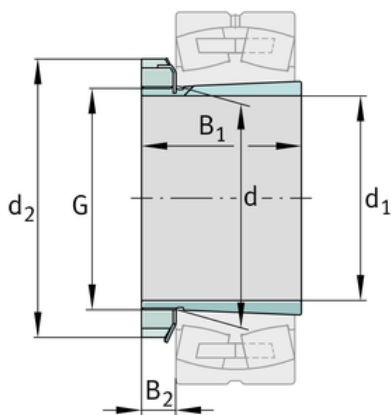
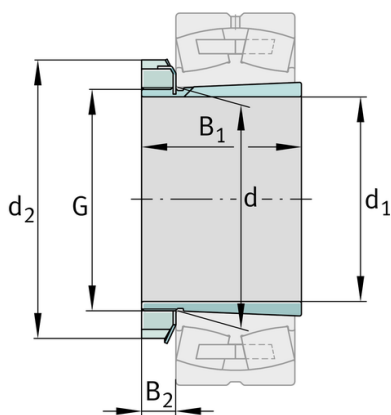
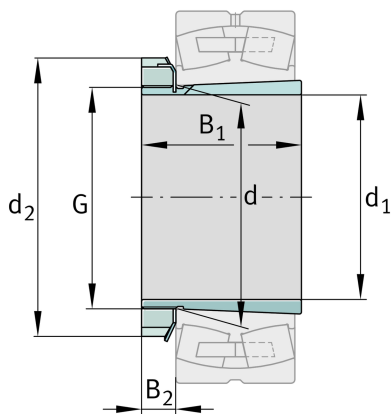

Main Dimensions & Performance Data

d_1	60 mm	bore diameter
G	M65x2	Thread
B_1	40 mm	sleeve length
	0,4 kg	Weight

Dimensions

d	65 mm	Bore diameter bearing
d_2	85 mm	Outside diameter nut
B_2	13,5 mm	Width nut and lock

Additional information

	KM13	Locknut
	MB13	Fuse
	1:12	Taper

