

FAG

★ H217

Adapter sleeve

Schaeffler ID:
0167306580000

Adapter sleeve H, accessory rolling bearing, complete, mechanical, FP

★ Preferred product

Technical information

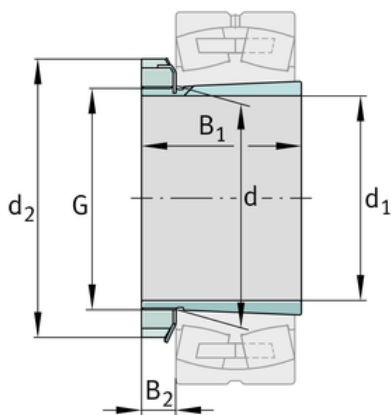
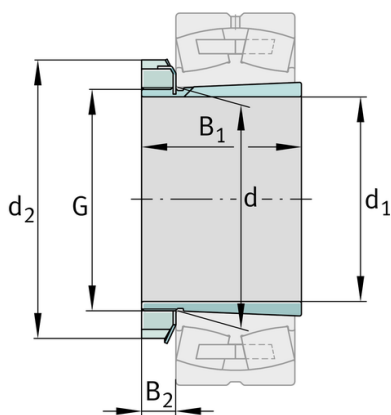
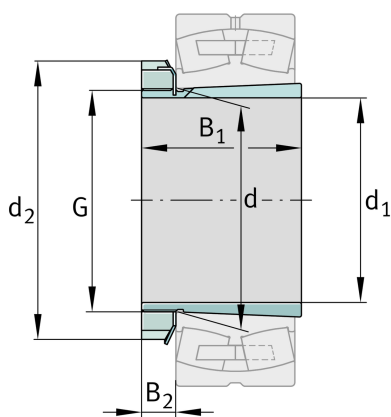

Main Dimensions & Performance Data

d_1	75 mm	bore diameter
G	M85x2	Thread
B_1	50 mm	sleeve length
	0,995 kg	Weight

Dimensions

d	85 mm	Bore diameter bearing
d_2	110 mm	Outside diameter nut
B_2	17,75 mm	Width nut and lock

Additional information

	KM17	Locknut
	MB17	Fuse
	1:12	Taper

