



FAG

★ H219

Adapter sleeve

Schaeffler ID:
0167306740000

Adapter sleeve H, accessory rolling bearing, complete, mechanical, FP

★ Preferred product

Technical information

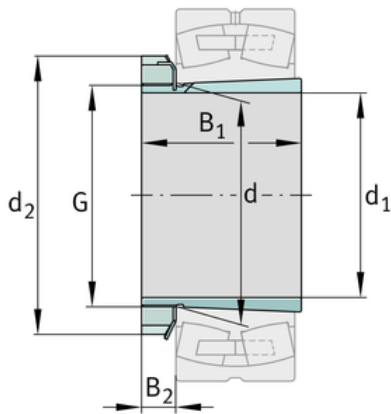
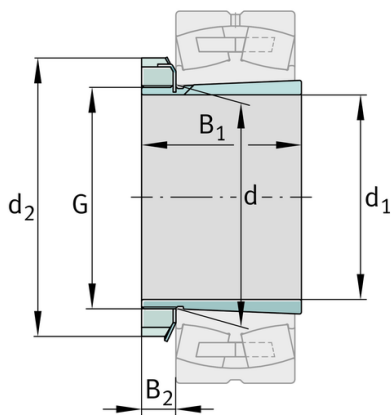
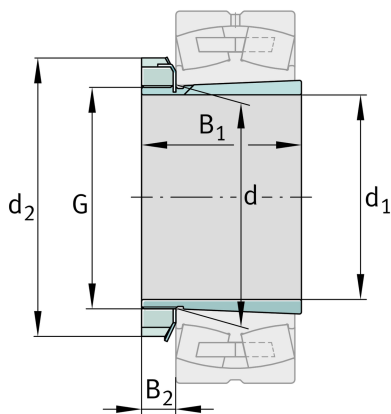

Main Dimensions & Performance Data

d_1	85 mm	bore diameter
G	M95x2	Thread
B_1	55 mm	sleeve length
	1,437 kg	Weight

Dimensions

d	95 mm	Bore diameter bearing
d_2	125 mm	Outside diameter nut
B_2	18,75 mm	Width nut and lock

Additional information

	KM19	Locknut
	MB19	Fuse
	1:12	Taper

