

FAG

★ **H222**

Adapter sleeve

Schaeffler ID:
0167307040000

Adapter sleeve H, accessory rolling bearing, complete, mechanical, FP

★ Preferred product

Technical information

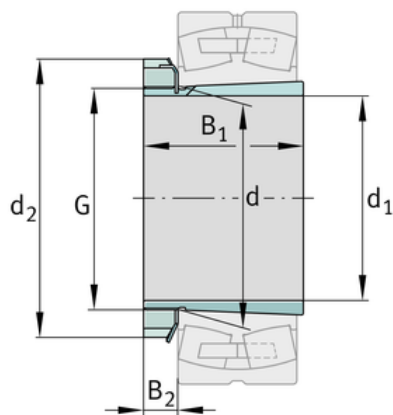
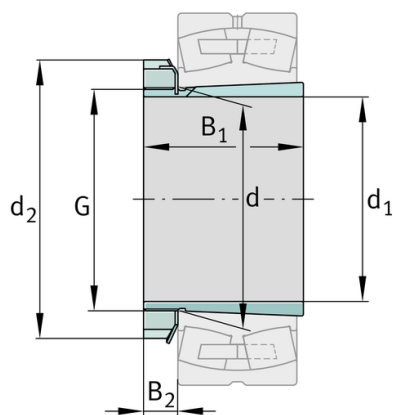
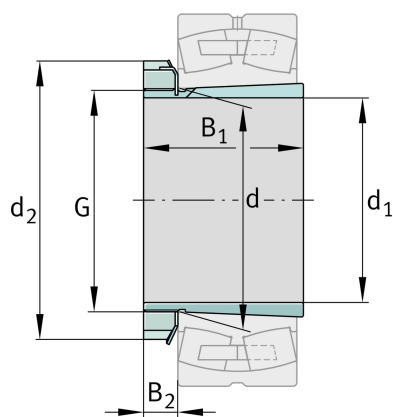

Main Dimensions & Performance Data

d_1	100 mm	bore diameter
G	M110x2	Thread
B_1	63 mm	sleeve length
	1,99 kg	Weight

Dimensions

d	110 mm	Bore diameter bearing
d_2	145 mm	Outside diameter nut
B_2	20,75 mm	Width nut and lock

Additional information

	KM22	Locknut
	MB22	Fuse
	1:12	Taper

