

FAG

★ **H2311**

Adapter sleeve

Schaeffler ID:
0167307550000

Adapter sleeve H, accessory rolling bearing, complete, mechanical, FP

★ Preferred product

Technical information

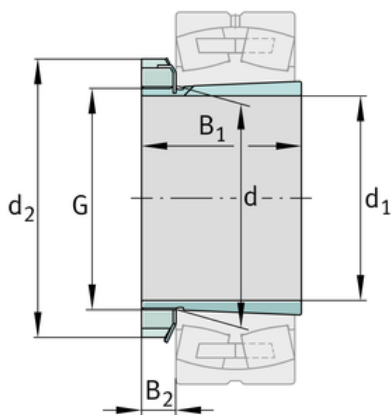
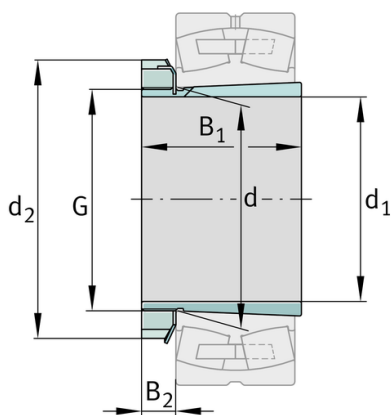
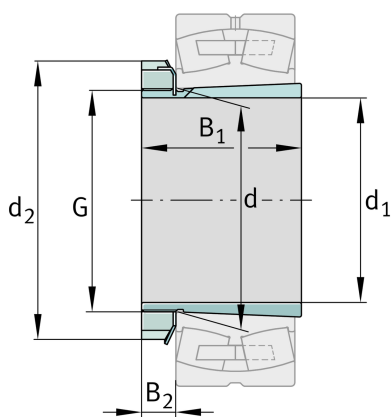

Main Dimensions & Performance Data

d_1	50 mm	bore diameter
G	M55x2	Thread
B_1	59 mm	sleeve length
	0,004 kg	Weight

Dimensions

d	55 mm	Bore diameter bearing
d_2	75 mm	Outside diameter nut
B_2	12,5 mm	Width nut and lock

Additional information

	KM11	Locknut
	MB11	Fuse
	1:12	Taper

