

FAG

★ H2314

Adapter sleeve

Schaeffler ID:
0191748960000Adapter sleeve H, accessory rolling
bearing, complete, mechanical, FP

★ Preferred product

Technical information

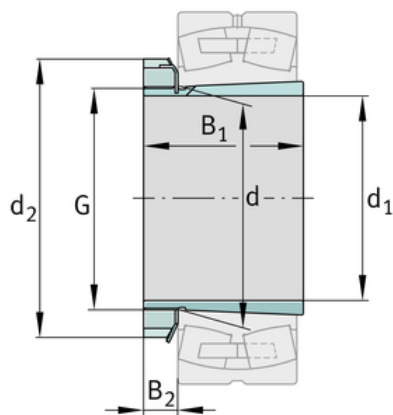
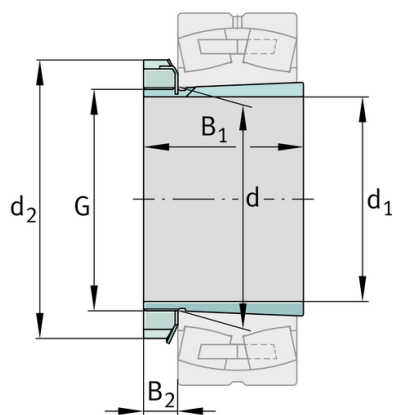
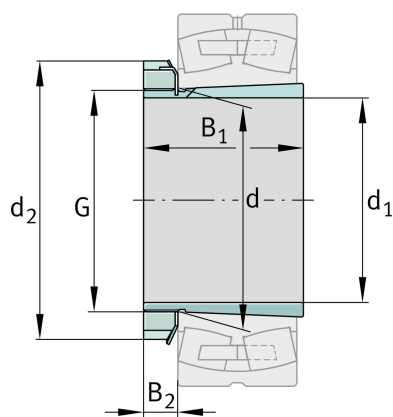

Main Dimensions & Performance Data

d_1	60 mm	bore diameter
G	M70x2	Thread
B_1	68 mm	sleeve length
	0,922 kg	Weight

Dimensions

d	70 mm	Bore diameter bearing
d_2	92 mm	Outside diameter nut
B_2	13,5 mm	Width nut and lock

Additional information

	KM14	Locknut
	MB14	Fuse
	1:12	Taper

