

FAG

★ H2317

Adapter sleeve

Schaeffler ID:
0167308010000Adapter sleeve H, accessory rolling
bearing, complete, mechanical, FP

★ Preferred product

Technical information

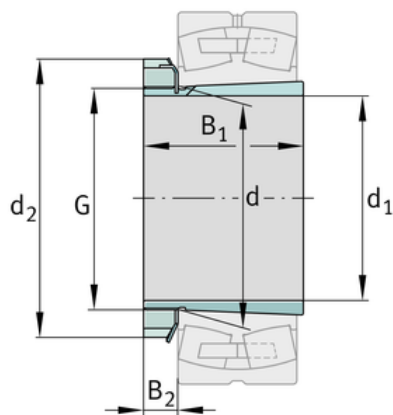
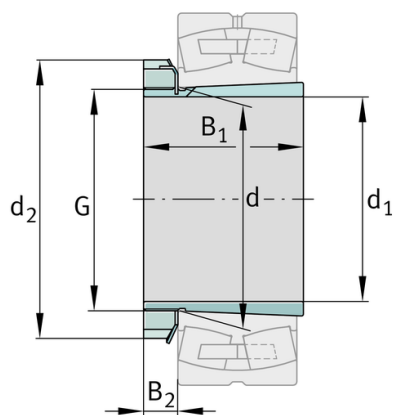
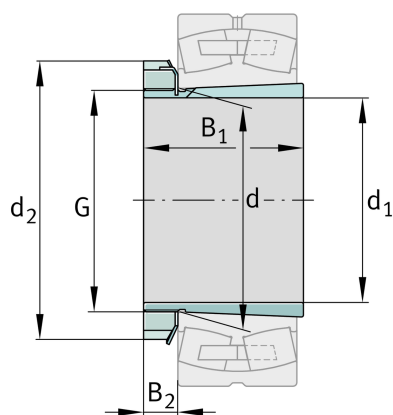

Main Dimensions & Performance Data

d_1	75 mm	bore diameter
G	M85x2	Thread
B_1	82 mm	sleeve length
	1,541 kg	Weight

Dimensions

d	85 mm	Bore diameter bearing
d_2	110 mm	Outside diameter nut
B_2	17,75 mm	Width nut and lock

Additional information

	KM17	Locknut
	MB17	Fuse
	1:12	Taper

