

FAG

★ **H2318**

Adapter sleeve

Schaeffler ID:
0167308100000

Adapter sleeve H, accessory rolling bearing, complete, mechanical, FP

★ Preferred product

Technical information

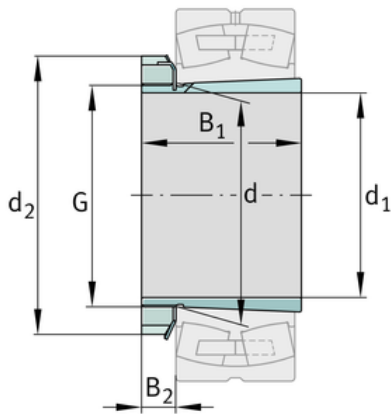
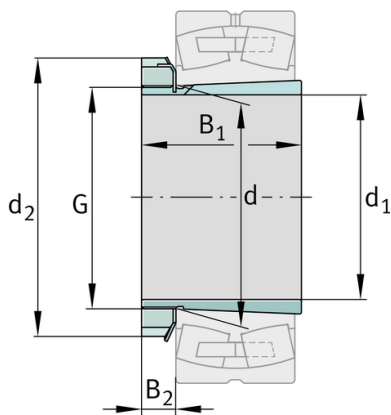
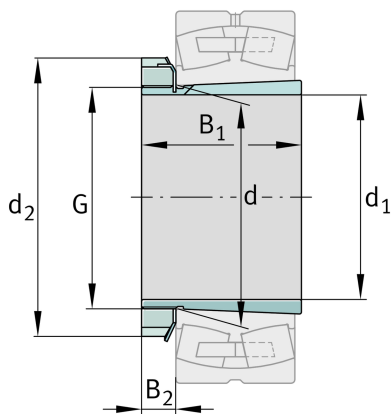

Main Dimensions & Performance Data

d_1	80 mm	bore diameter
G	M90x2	Thread
B_1	86 mm	sleeve length
	1,75 kg	Weight

Dimensions

d	90 mm	Bore diameter bearing
d_2	120 mm	Outside diameter nut
B_2	17,75 mm	Width nut and lock

Additional information

	KM18	Locknut
	MB18	Fuse
	1:12	Taper

