

FAG

## ★ H2319

## Adapter sleeve

Schaeffler ID:  
0167308280000Adapter sleeve H, accessory rolling  
bearing, complete, mechanical, FP

★ Preferred product

## Technical information

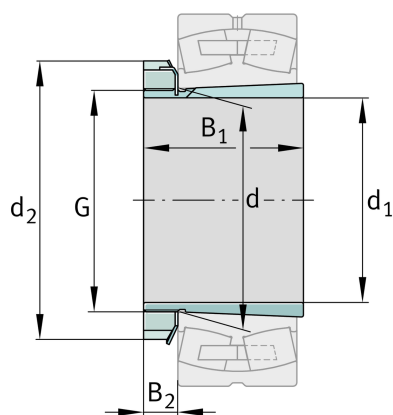

## Main Dimensions &amp; Performance Data

$d_1$	85 mm	bore diameter
G	M95x2	Thread
$B_1$	90 mm	sleeve length
	2,042 kg	Weight

## Dimensions

d	95 mm	Bore diameter bearing
$d_2$	125 mm	Outside diameter nut
$B_2$	18,75 mm	Width nut and lock

## Additional information

	KM19	Locknut
	MB19	Fuse
	1:12	Taper

