

FAG

★ H2320

Adapter sleeve

Schaeffler ID:
0167308360000Adapter sleeve H, accessory rolling
bearing, complete, mechanical, FP

★ Preferred product

Technical information

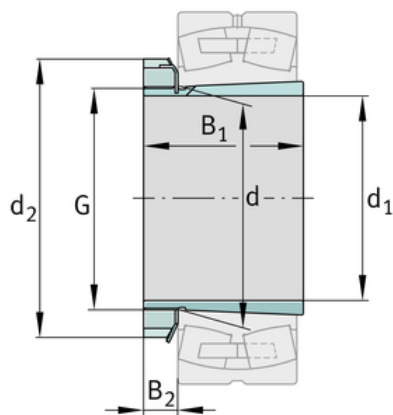
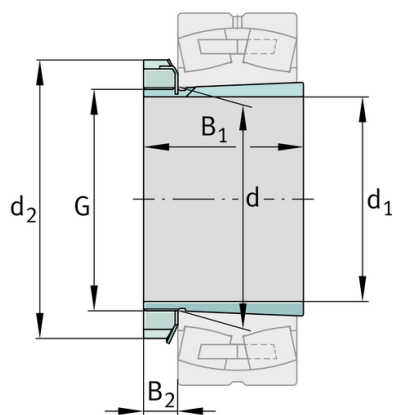
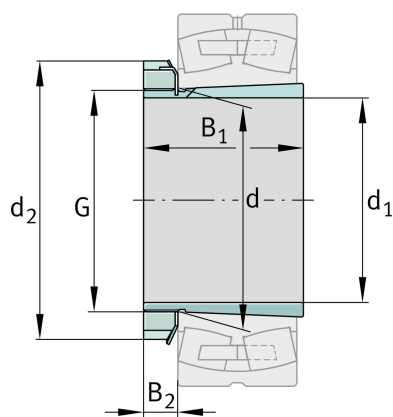

Main Dimensions & Performance Data

d_1	90 mm	bore diameter
G	M100x2	Thread
B_1	97 mm	sleeve length
	2,2 kg	Weight

Dimensions

d	100 mm	Bore diameter bearing
d_2	130 mm	Outside diameter nut
B_2	19,75 mm	Width nut and lock

Additional information

	KM20	Locknut
	MB20	Fuse
	1:12	Taper

