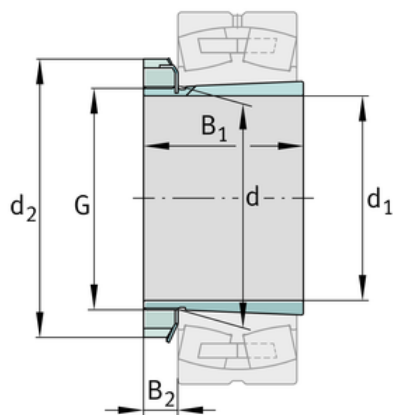
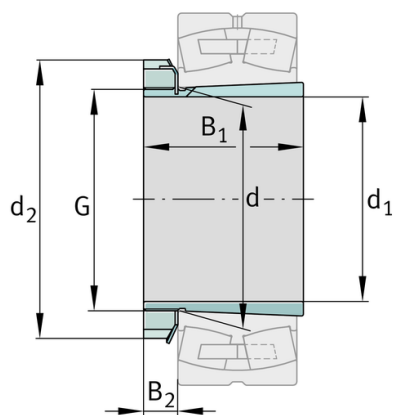
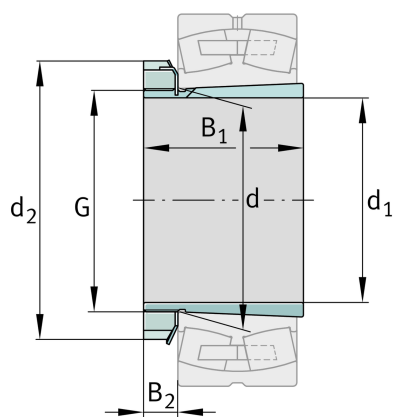

**FAG****H2352X**

## Adapter sleeve

Schaeffler ID:  
0191753370000Adapter sleeve H, accessory rolling  
bearing, complete, mechanical, FP

## Technical information

**Main Dimensions & Performance Data**

$d_1$	240 mm	bore diameter
G	Tr260X4	Thread
$B_1$	211 mm	sleeve length
	25,9 kg	Weight

**Dimensions**

d	260 mm	Bore diameter bearing
$d_2$	330 mm	Outside diameter nut
$B_2$	38 mm	Width nut and lock

**Additional information**

	HM52T	Locknut
	MB52	Fuse
	1:12	Taper

