



FAG

H2356X-HG

Adapter sleeve

Schaeffler ID:
0191753880000Adapter sleeve H.-HG, accessory rolling
bearing, complete, hydraulic, FP

Technical information

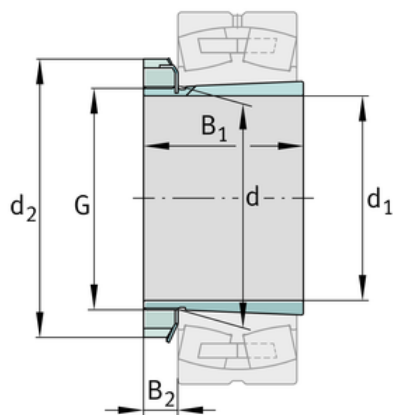
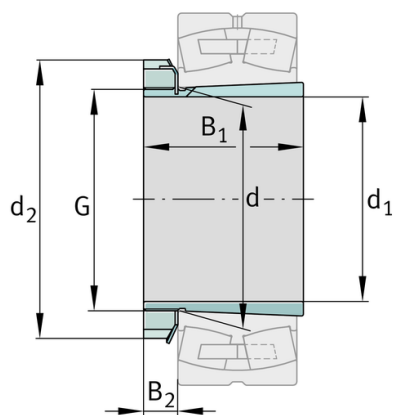
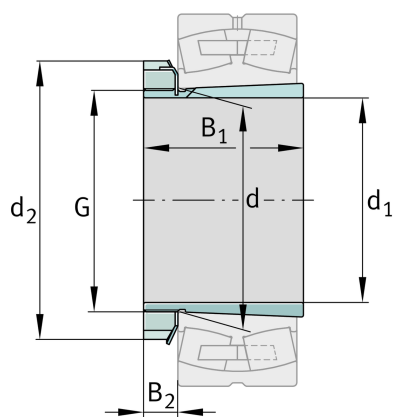
**Main Dimensions & Performance Data**

d_1	260 mm	bore diameter
G	Tr280X4	Thread
B_1	224 mm	sleeve length
	29,6 kg	Weight

Dimensions

d	280 mm	bore diameter
d_2	350 mm	Outside diameter
B_2	39 mm	Width nut and lock

Mounting dimensions

G_1	M6	Thread oil connector
a	4,2 mm	Distance oil connector
l_{G1}	7 mm	Thread depth oil connector

Additional information

	HM56T	Locknut
	MB56	Fuse
	1:12	Taper

