

FAG

★ H306

Adapter sleeve

Schaeffler ID:
0167310340000Adapter sleeve H, accessory rolling
bearing, complete, mechanical, FP

★ Preferred product

Technical information

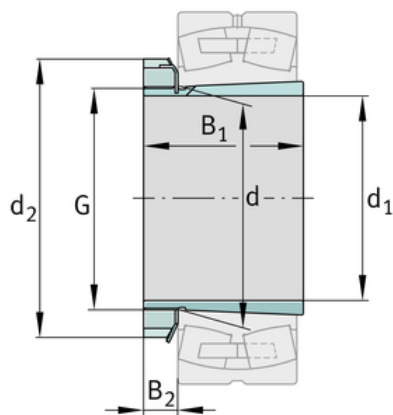
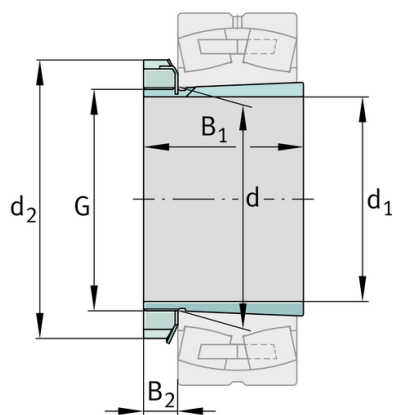
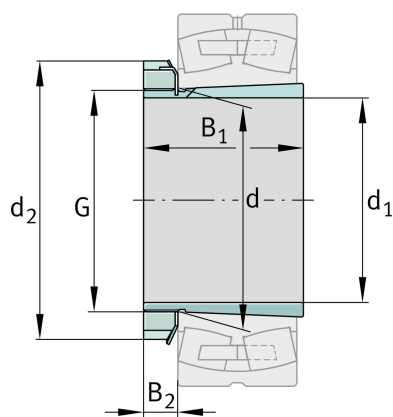

Main Dimensions & Performance Data

d_1	25 mm	bore diameter
G	M30x1,5	Thread
B_1	31 mm	sleeve length
	0,106 kg	Weight

Dimensions

d	30 mm	Bore diameter bearing
d_2	45 mm	Outside diameter nut
B_2	8,25 mm	Width nut and lock

Additional information

	KM6	Locknut
	MB6	Fuse
	1:12	Taper

