



**FAG**

★ **H310**

Adapter sleeve

Schaeffler ID:  
0167310850000

Adapter sleeve H, accessory rolling bearing, complete, mechanical, FP

★ Preferred product

Technical information

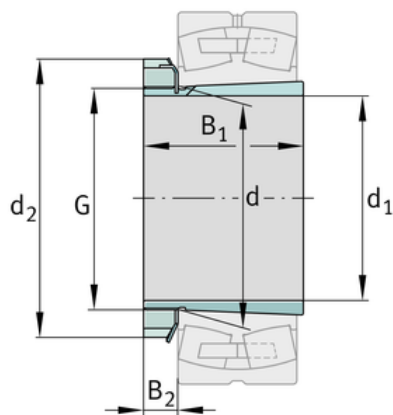
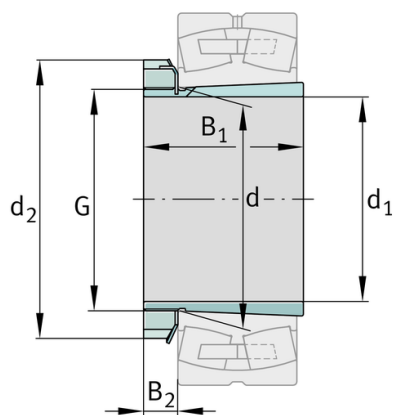
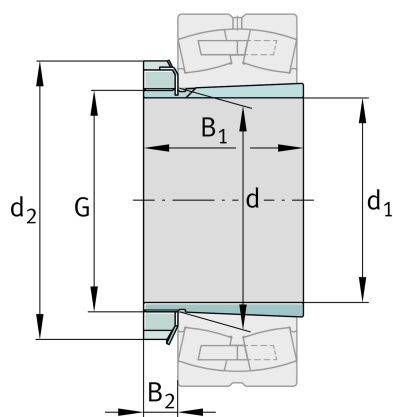

**Main Dimensions & Performance Data**

$d_1$	45 mm	bore diameter
G	M50x1,5	Thread
$B_1$	42 mm	sleeve length
	0,003 kg	Weight

**Dimensions**

d	50 mm	Bore diameter bearing
$d_2$	70 mm	Outside diameter nut
$B_2$	12,25 mm	Width nut and lock

**Additional information**

	KM10	Locknut
	MB10	Fuse
	1:12	Taper

