

FAG

★ **H312**

Adapter sleeve

Schaeffler ID:
0167311070000

Adapter sleeve H, accessory rolling bearing, complete, mechanical, FP

★ Preferred product

Technical information

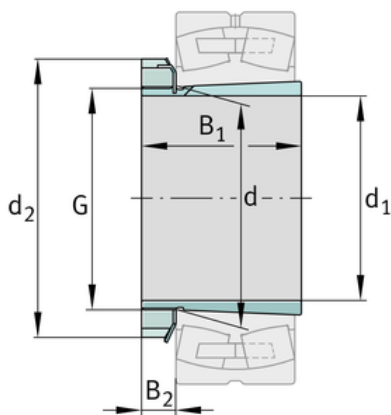
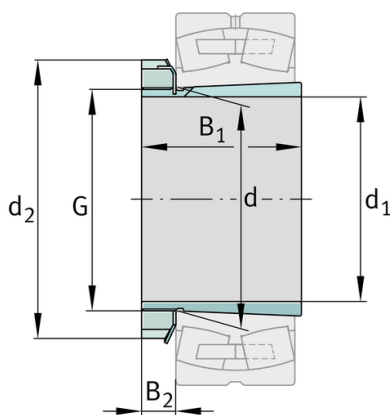
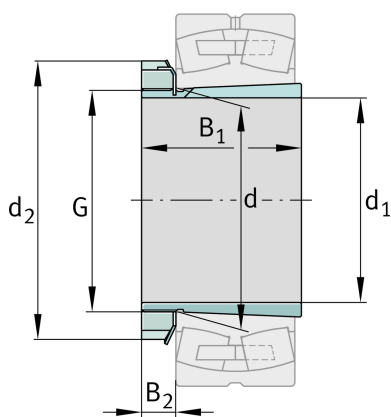

Main Dimensions & Performance Data

d_1	55 mm	bore diameter
G	M60x2	Thread
B_1	47 mm	sleeve length
	0,41 kg	Weight

Dimensions

d	60 mm	Bore diameter bearing
d_2	80 mm	Outside diameter nut
B_2	12,5 mm	Width nut and lock

Additional information

	KM12	Locknut
	MB12	Fuse
	1:12	Taper

