

**FAG**★ **H313**

## Adapter sleeve

Schaeffler ID:  
0167311660000Adapter sleeve H, accessory rolling  
bearing, complete, mechanical, FP

★ Preferred product

## Technical information

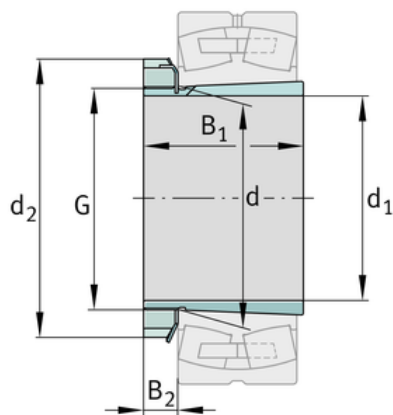
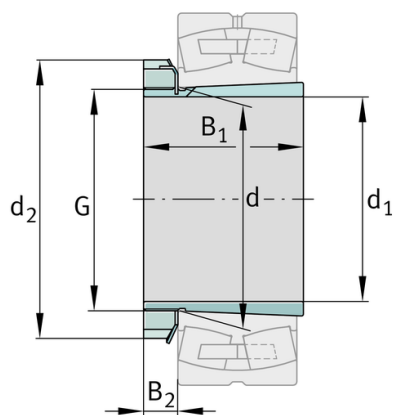
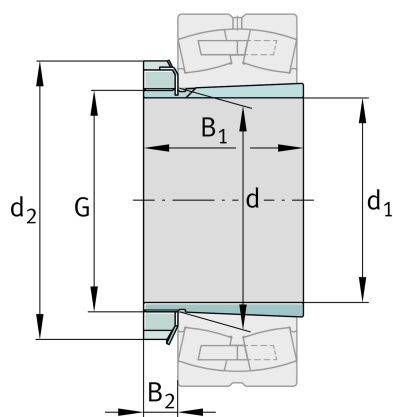
**Main Dimensions & Performance Data**

$d_1$	60 mm	bore diameter
G	M65x2	Thread
$B_1$	50 mm	sleeve length
	0,5 kg	Weight

**Dimensions**

d	65 mm	Bore diameter bearing
$d_2$	85 mm	Outside diameter nut
$B_2$	13,5 mm	Width nut and lock

**Additional information**

	KM13	Locknut
	MB13	Fuse
	1:12	Taper

