

FAG

★ H318

Adapter sleeve

Schaeffler ID:
0167312980000Adapter sleeve H, accessory rolling
bearing, complete, mechanical, FP

★ Preferred product

Technical information

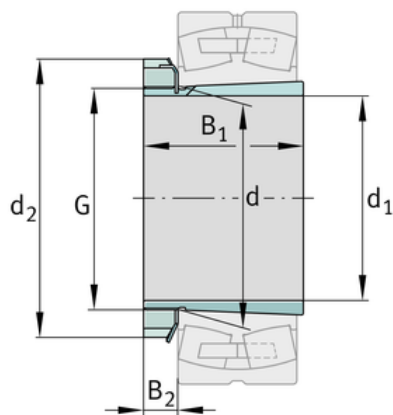
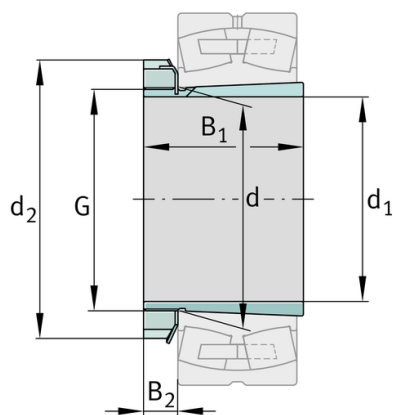
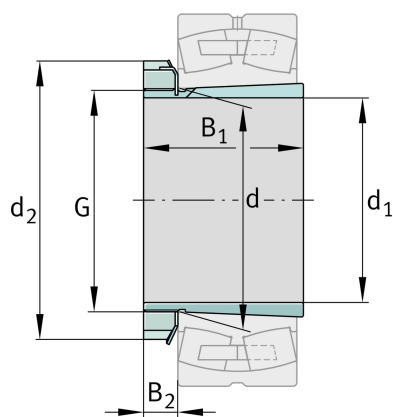

Main Dimensions & Performance Data

d_1	80 mm	bore diameter
G	M90x2	Thread
B_1	65 mm	sleeve length
	1,41 kg	Weight

Dimensions

d	90 mm	Bore diameter bearing
d_2	120 mm	Outside diameter nut
B_2	17,75 mm	Width nut and lock

Additional information

	KM18	Locknut
	MB18	Fuse
	1:12	Taper

