

**FAG**

★ **H319**

Adapter sleeve

Schaeffler ID:  
0167313010000

Adapter sleeve H, accessory rolling bearing, complete, mechanical, FP

★ Preferred product

Technical information

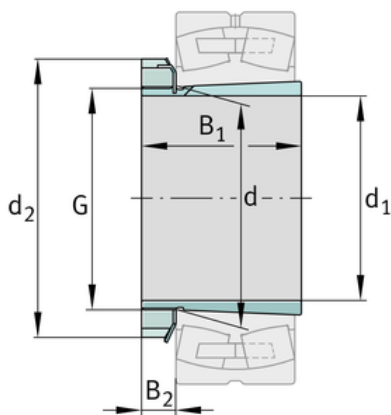
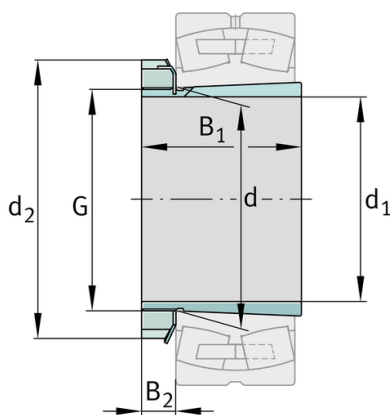
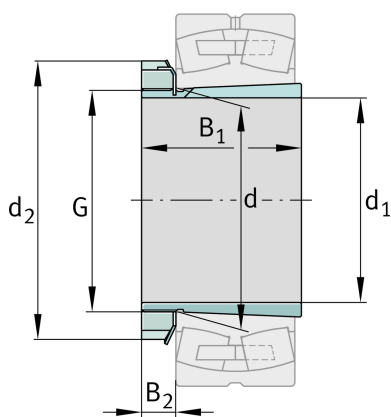

**Main Dimensions & Performance Data**

$d_1$	85 mm	bore diameter
G	M95x2	Thread
$B_1$	68 mm	sleeve length
	1,637 kg	Weight

**Dimensions**

d	95 mm	Bore diameter bearing
$d_2$	125 mm	Outside diameter nut
$B_2$	18,75 mm	Width nut and lock

**Additional information**

	KM19	Locknut
	MB19	Fuse
	1:12	Taper

