

FAG

## ★ H322

## Adapter sleeve

Schaeffler ID:  
0167313360000Adapter sleeve H, accessory rolling  
bearing, complete, mechanical, FP

★ Preferred product

## Technical information

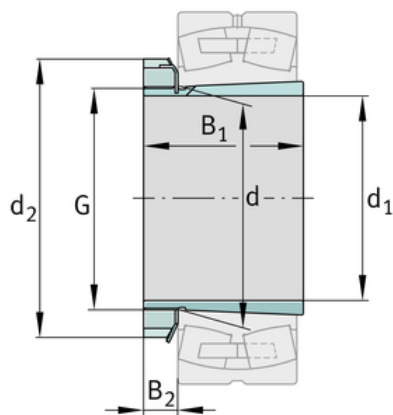
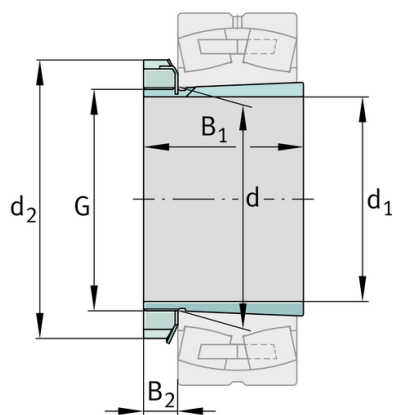
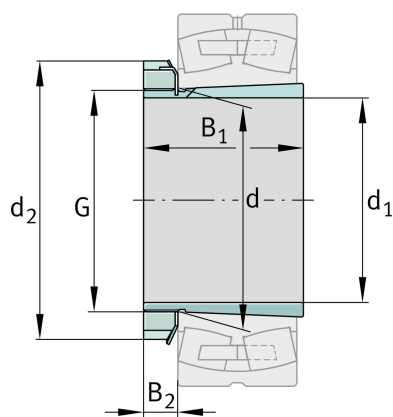

## Main Dimensions &amp; Performance Data

$d_1$	100 mm	bore diameter
G	M110x2	Thread
$B_1$	77 mm	sleeve length
	2,3 kg	Weight

## Dimensions

d	110 mm	Bore diameter bearing
$d_2$	145 mm	Outside diameter nut
$B_2$	20,75 mm	Width nut and lock

## Additional information

	KM22	Locknut
	MB22	Fuse
	1:12	Taper

