

FAG

★ **H3030**

Adapter sleeve

Schaeffler ID:
0167309410000

Adapter sleeve H, accessory rolling bearing, complete, mechanical, FP

★ Preferred product

Technical information

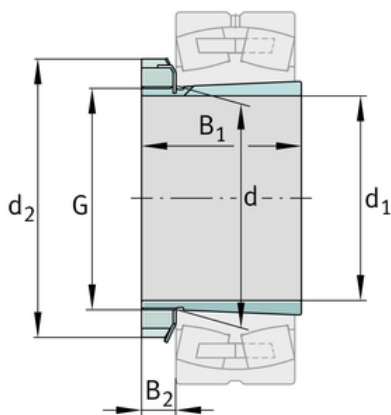
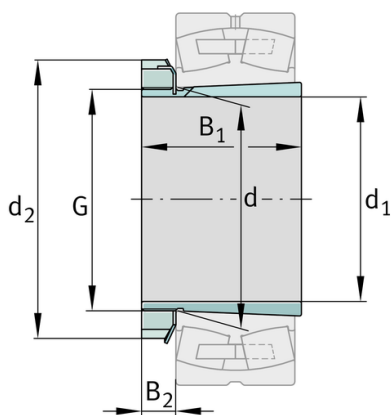
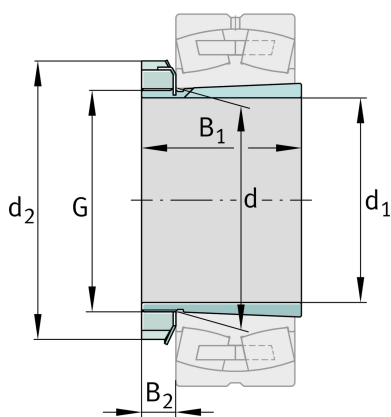

Main Dimensions & Performance Data

d_1	135 mm	bore diameter
G	M150x2	Thread
B_1	87 mm	sleeve length
	4,194 kg	Weight

Dimensions

d	150 mm	Bore diameter bearing
d_2	180 mm	Outside diameter nut
B_2	26 mm	Width nut and lock

Additional information

	KML30	Locknut
	MBL30	Fuse
	1:12	Taper

