

FAG

★ **H3036**

Adapter sleeve

Schaeffler ID:
0167309760000

Adapter sleeve H, accessory rolling bearing, complete, mechanical, FP

★ Preferred product

Technical information

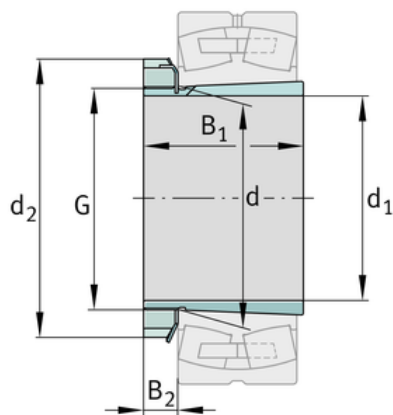
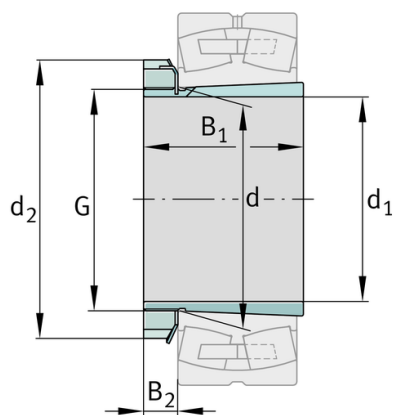
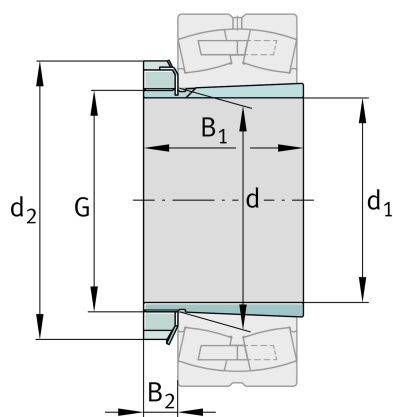

Main Dimensions & Performance Data

d_1	160 mm	bore diameter
G	M180x3	Thread
B_1	109 mm	sleeve length
	7,247 kg	Weight

Dimensions

d	180 mm	Bore diameter bearing
d_2	210 mm	Outside diameter nut
B_2	29,5 mm	Width nut and lock

Additional information

	KML36	Locknut
	MBL36	Fuse
	1:12	Taper

