

FAG

★ **H3126**

Adapter sleeve

Schaeffler ID:
0167311310000

Adapter sleeve H, accessory rolling bearing, complete, mechanical, FP

★ Preferred product

Technical information

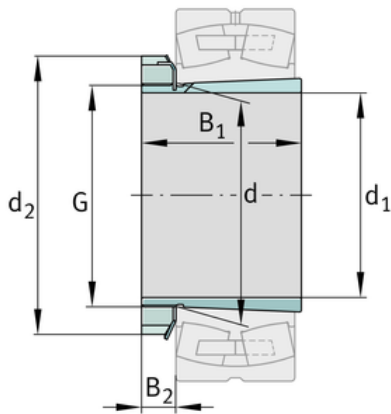
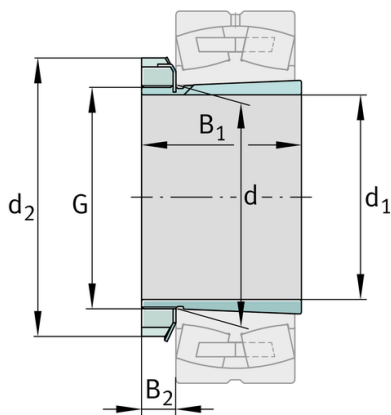
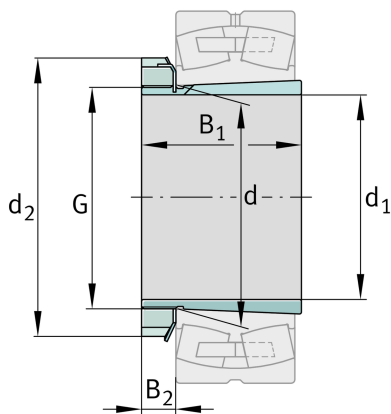

Main Dimensions & Performance Data

d_1	115 mm	bore diameter
G	M130x2	Thread
B_1	92 mm	sleeve length
	3,82 kg	Weight

Dimensions

d	130 mm	Bore diameter bearing
d_2	165 mm	Outside diameter nut
B_2	23 mm	Width nut and lock

Additional information

	KM26	Locknut
	MB26	Fuse
	1:12	Taper

