

FAG

★ H3134

Adapter sleeve

Schaeffler ID:
0167311900000Adapter sleeve H, accessory rolling
bearing, complete, mechanical, FP

★ Preferred product

Technical information

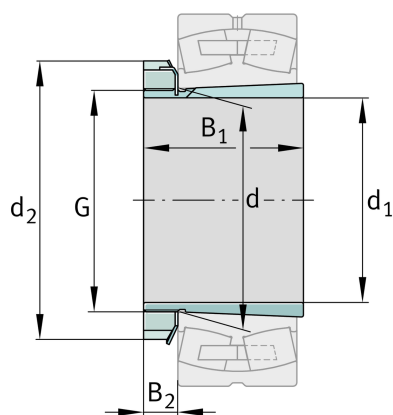

Main Dimensions & Performance Data

d_1	150 mm	bore diameter
G	M170x3	Thread
B_1	122 mm	sleeve length
	8,68 kg	Weight

Dimensions

d	170 mm	Bore diameter bearing
d_2	220 mm	Outside diameter nut
B_2	28,5 mm	Width nut and lock

Additional information

	KM34	Locknut
	MB34	Fuse
	1:12	Taper

