

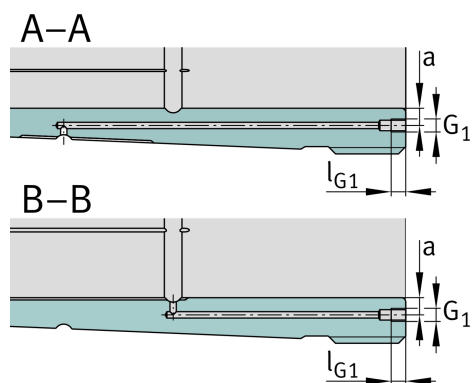

## Technical information

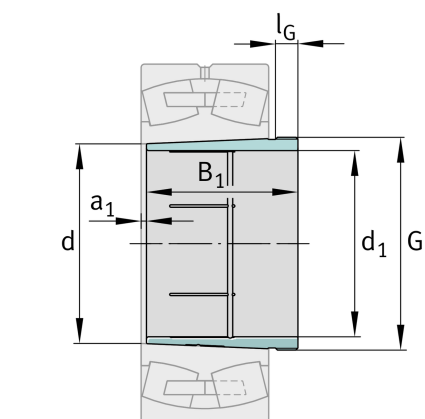

## Main Dimensions & Performance Data

$d_1$	190 mm	bore diameter
G	Tr220X4	Thread
$B_1$	170 mm	sleeve length
	7,7 kg	Weight

## Dimensions

d	200 mm	Bore diameter
$a_1$	7 mm	Bearing overhang
$l_G$	30 mm	Thread length

## Mounting dimensions

$G_1$	M6	Thread oil connector
a	4,5 mm	Distance oil connector
$l_{G1}$	7 mm	Thread depth oil connector

## Additional information

	1:12	Taper
--	------	-------

