

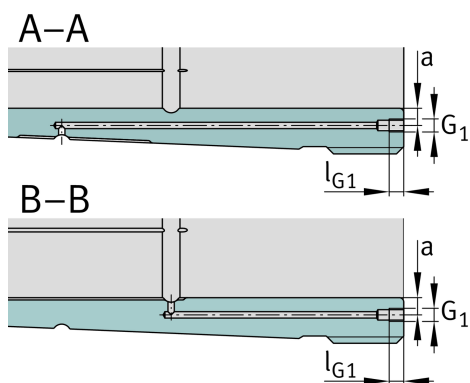

Technical information

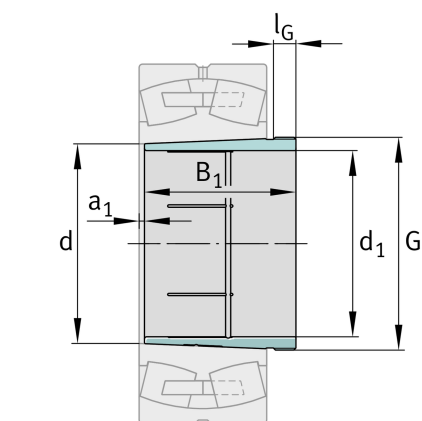

Main Dimensions & Performance Data

d_1	260 mm	bore diameter
G	Tr310X5	Thread
B_1	212 mm	sleeve length
	22,3 kg	Weight

Dimensions

d	280 mm	Bore diameter
a_1	8 mm	Bearing overhang
l_G	30 mm	Thread length

Mounting dimensions

G_1	G1/8	Thread oil connector
a	8,5 mm	Distance oil connector
l_{G1}	12 mm	Thread depth oil connector

Additional information

	1:12	Taper
--	------	-------

