

FAG

★ 3206-BD-XL-TVH

Angular contact ball bearing

Schaeffler ID:
0606414950000

Angular contact ball bearing 32..-BD-XL-TVH, double row, X-life, plastic cage

★ Preferred product

X-life

Technical information

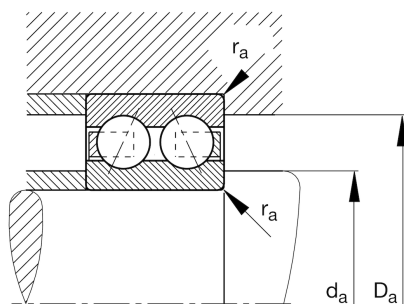
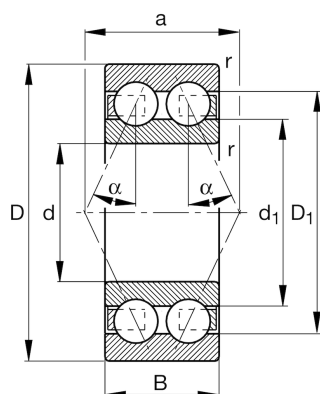

Temperature range

T_{\min}	-30 °C	Operating temperature min.
T_{\max}	120 °C	Operating temperature max.
	0,278 kg	Weight

Main Dimensions & Performance Data

d	30 mm	Bore diameter
D	62 mm	Outside diameter
B	23,8 mm	Width
C_r	31.000 N	Basic dynamic load rating, radial
C_{0r}	22.200 N	Basic static load rating, radial
C_{ur}	1.540 N	Fatigue load limit, radial
n_G	11.900 1/min	Limiting speed
n_{gr}	11.100 1/min	Reference speed

Dimensions

r_{\min}	1 mm	Minimum chamfer dimension
D_1	53,3 mm	Shoulder diameter outer ring
d_1	42,2 mm	Shoulder diameter inner ring
a	36,4 mm	Distance between the apexes of the pressure cones
α	30 °	Contact angle

Mounting dimensions

$d_{a \min}$	35,6 mm	Minimum diameter shaft shoulder
$D_{a \max}$	56,4 mm	Maximum diameter of housing shoulder
$r_{a \max}$	1 mm	Maximum fillet radius