

FAG

★ 3208-BD-XL

Angular contact ball bearing

Schaeffler ID:
0709370600000Angular contact ball bearing 32..-BD-XL,
double row, X-life, steel sheet metal cage

★ Preferred product

X-life

Technical information

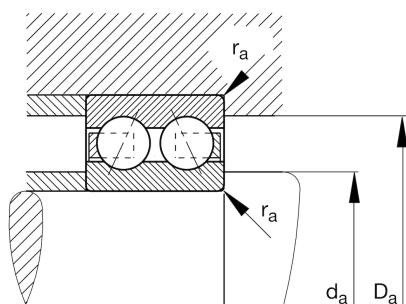
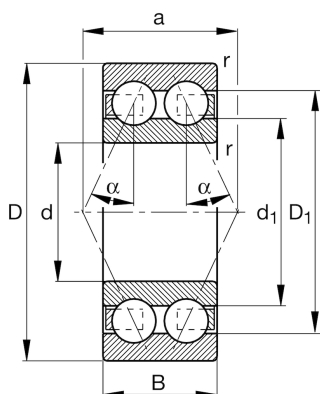

Temperature range

T_{min}	-30 °C	Operating temperature min.
T_{max}	120 °C	Operating temperature max.
	0,593 kg	Weight

Main Dimensions & Performance Data

d	40 mm	Bore diameter
D	80 mm	Outside diameter
B	30,2 mm	Width
C_r	51.000 N	Basic dynamic load rating, radial
C_{0r}	38.000 N	Basic static load rating, radial
C_{ur}	2.650 N	Fatigue load limit, radial
n_G	8.900 1/min	Limiting speed
n_{gr}	9.100 1/min	Reference speed

Dimensions

r_{min}	1,1 mm	Minimum chamfer dimension
D_1	69,6 mm	Shoulder diameter outer ring
d_1	54,9 mm	Shoulder diameter inner ring
a	47,4 mm	Distance between the apexes of the pressure cones
α	30 °	Contact angle

Mounting dimensions

$d_{a min}$	47 mm	Minimum diameter shaft shoulder
$D_{a max}$	73 mm	Maximum diameter of housing shoulder
$r_{a max}$	1 mm	Maximum fillet radius