

FAG

★ 3208-BD-XL-2HRS-TVH

Angular contact ball bearing

Schaeffler ID:
0638556070000Angular contact ball bearing 32..-BD-
XL-2HRS-TVH, double row, X-life, seals,
plastic cage

★ Preferred product

X-life

Technical information

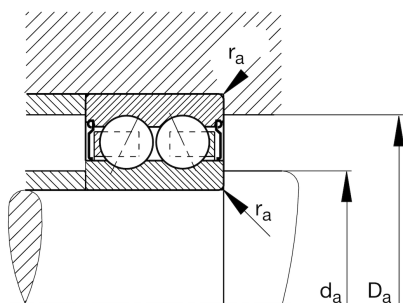
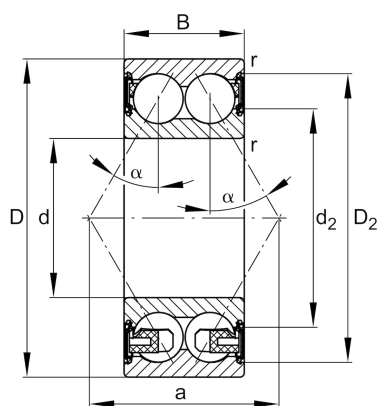

Temperature range

T_{\min}	-20 °C	Operating temperature min.
T_{\max}	110 °C	Operating temperature max.
	0,592 kg	Weight

Main Dimensions & Performance Data

d	40 mm	Bore diameter
D	80 mm	Outside diameter
B	30,2 mm	Width
C_r	51.000 N	Basic dynamic load rating, radial
C_{0r}	38.000 N	Basic static load rating, radial
C_{ur}	2.650 N	Fatigue load limit, radial
n_G	6.700 1/min	Limiting speed

Dimensions

r_{\min}	1,1 mm	Minimum chamfer dimension
D_2	72,6 mm	Caliber diameter outer ring
d_2	52,8 mm	Caliber diameter inner ring
a	47,4 mm	Distance between the apexes of the pressure cones
α	30 °	Contact angle

Mounting dimensions

$d_{a \min}$	47 mm	Minimum diameter shaft shoulder
$D_{a \max}$	73 mm	Maximum diameter of housing shoulder
$r_{a \max}$	1 mm	Maximum fillet radius