



FAG

★ 3209-BD-XL-2HRS-TVH

Angular contact ball bearing

Schaeffler ID:
0627738280000Angular contact ball bearing 32..-BD-
XL-2HRS-TVH, double row, X-life, seals,
plastic cage

★ Preferred product

X-life

Technical information

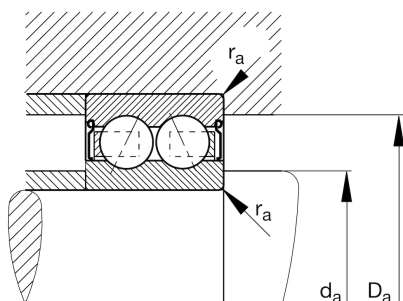

Temperature range

T_{\min}	-20 °C	Operating temperature min.
T_{\max}	110 °C	Operating temperature max.
	0,627 kg	Weight

Main Dimensions & Performance Data

d	45 mm	Bore diameter
D	85 mm	Outside diameter
B	30,2 mm	Width
C_r	50.000 N	Basic dynamic load rating, radial
C_{0r}	39.000 N	Basic static load rating, radial
C_{ur}	2.700 N	Fatigue load limit, radial
n_G	6.300 1/min	Limiting speed

Dimensions

r_{\min}	1,1 mm	Minimum chamfer dimension
D_2	78,1 mm	Caliber diameter outer ring
d_2	57,7 mm	Caliber diameter inner ring
a	50,3 mm	Distance between the apexes of the pressure cones
α	30 °	Contact angle

Mounting dimensions

$d_{a \min}$	52 mm	Minimum diameter shaft shoulder
$D_{a \max}$	78 mm	Maximum diameter of housing shoulder
$r_{a \max}$	1 mm	Maximum fillet radius