

FAG

## ★ 3213-BD-XL

Angular contact ball bearing

Schaeffler ID:  
0712162860000Angular contact ball bearing 32..-BD-XL,  
double row, X-life, steel sheet metal cage

★ Preferred product

X-life

## Technical information

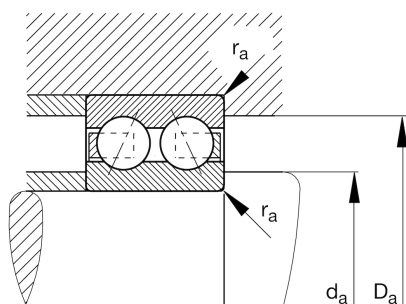
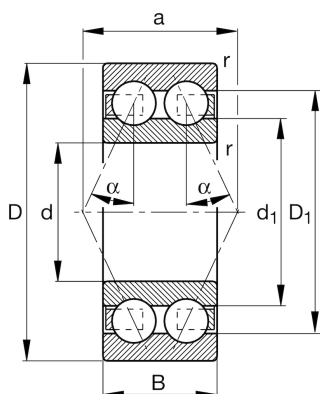

## Temperature range

$T_{min}$	-30 °C	Operating temperature min.
$T_{max}$	150 °C	Operating temperature max.
	1,67 kg	Weight

## Main Dimensions &amp; Performance Data

d	65 mm	Bore diameter
D	120 mm	Outside diameter
B	38,1 mm	Width
$C_r$	86.000 N	Basic dynamic load rating, radial
$C_{0r}$	77.000 N	Basic static load rating, radial
$C_{ur}$	5.300 N	Fatigue load limit, radial
$n_G$	5.700 1/min	Limiting speed
$n_{gr}$	6.000 1/min	Reference speed

## Dimensions

$r_{min}$	1,5 mm	Minimum chamfer dimension
$D_1$	106,6 mm	Shoulder diameter outer ring
$d_1$	87,7 mm	Shoulder diameter inner ring
a	70,6 mm	Distance between the apexes of the pressure cones
$\alpha$	30 °	Contact angle

## Mounting dimensions

$d_{a min}$	74 mm	Minimum diameter shaft shoulder
$D_{a max}$	111 mm	Maximum diameter of housing shoulder
$r_{a max}$	1,5 mm	Maximum fillet radius