



FAG

★ 3306-BD-XL-TVH

Angular contact ball bearing

Schaeffler ID:
0599478610000

Angular contact ball bearing 33..-BD-XL-TVH, double row, X-life, plastic cage

★ Preferred product

X-life

Technical information

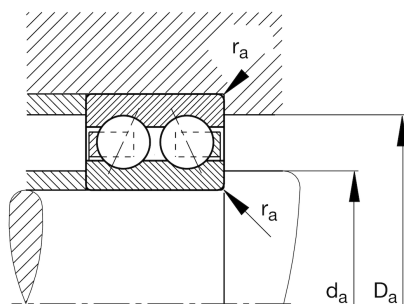
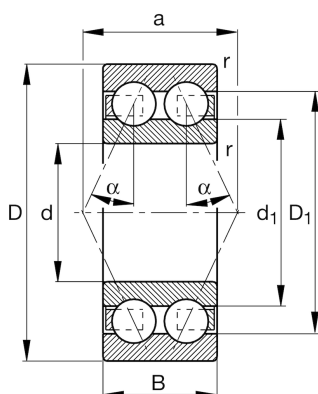

Temperature range

T_{\min}	-30 °C	Operating temperature min.
T_{\max}	120 °C	Operating temperature max.
	0,54 kg	Weight

Main Dimensions & Performance Data

d	30 mm	Bore diameter
D	72 mm	Outside diameter
B	30,2 mm	Width
C_r	43.000 N	Basic dynamic load rating, radial
C_{0r}	29.500 N	Basic static load rating, radial
C_{ur}	2.050 N	Fatigue load limit, radial
n_G	10.400 1/min	Limiting speed
n_{gr}	8.500 1/min	Reference speed

Dimensions

r_{\min}	1,1 mm	Minimum chamfer dimension
D_1	60,5 mm	Shoulder diameter outer ring
d_1	46,3 mm	Shoulder diameter inner ring
a	41,9 mm	Distance between the apexes of the pressure cones
α	30 °	Contact angle

Mounting dimensions

$d_{a \min}$	37 mm	Minimum diameter shaft shoulder
$D_{a \max}$	65 mm	Maximum diameter of housing shoulder
$r_{a \max}$	1 mm	Maximum fillet radius