

FAG

★ 3309-BD-XL

Angular contact ball bearing

Schaeffler ID:
0695031760000Angular contact ball bearing 33..-BD-XL,
double row, X-life, steel sheet metal cage

★ Preferred product

X-life

Technical information

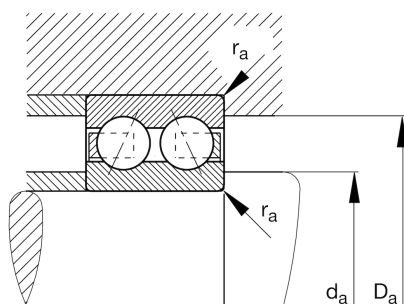
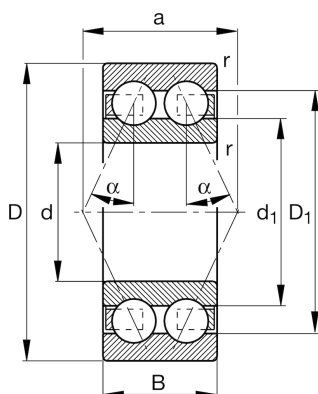

Temperature range

T_{min}	-30 °C	Operating temperature min.
T_{max}	150 °C	Operating temperature max.
	1,34 kg	Weight

Main Dimensions & Performance Data

d	45 mm	Bore diameter
D	100 mm	Outside diameter
B	39,7 mm	Width
C_r	72.000 N	Basic dynamic load rating, radial
C_{0r}	54.000 N	Basic static load rating, radial
C_{ur}	3.700 N	Fatigue load limit, radial
n_G	7.300 1/min	Limiting speed
n_{gr}	6.700 1/min	Reference speed

Dimensions

r_{min}	1,5 mm	Minimum chamfer dimension
D_1	84,4 mm	Shoulder diameter outer ring
d_1	65,5 mm	Shoulder diameter inner ring
a	57,8 mm	Distance between the apexes of the pressure cones
α	30 °	Contact angle

Mounting dimensions

$d_{a min}$	54 mm	Minimum diameter shaft shoulder
$D_{a max}$	91 mm	Maximum diameter of housing shoulder
$r_{a max}$	1,5 mm	Maximum fillet radius