



FAG

★ 3305-BD-XL-2HRS-TVH

Angular contact ball bearing

Schaeffler ID:
0624943090000Angular contact ball bearing 33..-BD-
XL-2HRS-TVH, double row, X-life, seals,
plastic cage

★ Preferred product

X-life

Technical information

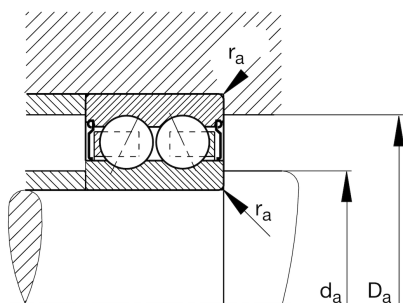
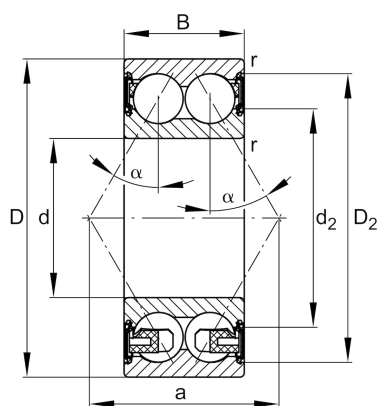

Temperature range

T_{\min}	-20 °C	Operating temperature min.
T_{\max}	110 °C	Operating temperature max.
	0,352 kg	Weight

Main Dimensions & Performance Data

d	25 mm	Bore diameter
D	62 mm	Outside diameter
B	25,4 mm	Width
C_r	31.500 N	Basic dynamic load rating, radial
C_{0r}	21.000 N	Basic static load rating, radial
C_{ur}	1.460 N	Fatigue load limit, radial
n_G	9.300 1/min	Limiting speed

Dimensions

r_{\min}	1,1 mm	Minimum chamfer dimension
D_2	53,7 mm	Caliber diameter outer ring
d_2	37,6 mm	Caliber diameter inner ring
a	35,4 mm	Distance between the apexes of the pressure cones
α	30 °	Contact angle

Mounting dimensions

$d_{a \min}$	32 mm	Minimum diameter shaft shoulder
$D_{a \max}$	55 mm	Maximum diameter of housing shoulder
$r_{a \max}$	1 mm	Maximum fillet radius