

FAG

★ 3311-BD-XL-2HRS-TVH

Angular contact ball bearing

Schaeffler ID:
0627077280000Angular contact ball bearing 33..-BD-
XL-2HRS-TVH, double row, X-life, seals,
plastic cage

★ Preferred product

X-life

Technical information

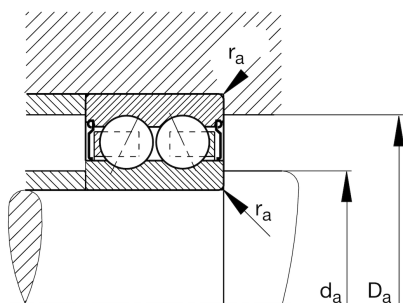
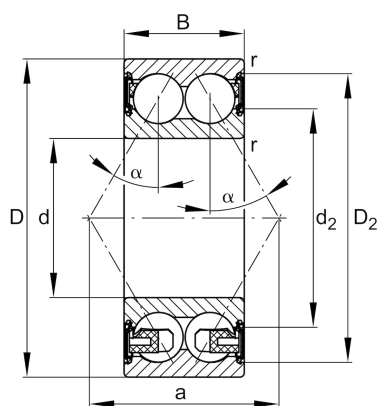

Temperature range

T_{\min}	-20 °C	Operating temperature min.
T_{\max}	110 °C	Operating temperature max.
	2,3 kg	Weight

Main Dimensions & Performance Data

d	55 mm	Bore diameter
D	120 mm	Outside diameter
B	49,2 mm	Width
C_r	116.000 N	Basic dynamic load rating, radial
C_{0r}	88.000 N	Basic static load rating, radial
C_{ur}	6.100 N	Fatigue load limit, radial
n_G	4.350 1/min	Limiting speed

Dimensions

r_{\min}	2 mm	Minimum chamfer dimension
D_2	106,8 mm	Caliber diameter outer ring
d_2	76,4 mm	Caliber diameter inner ring
a	71,4 mm	Distance between the apexes of the pressure cones
α	30 °	Contact angle

Mounting dimensions

$d_{a \min}$	66 mm	Minimum diameter shaft shoulder
$D_{a \max}$	109 mm	Maximum diameter of housing shoulder
$r_{a \max}$	2 mm	Maximum fillet radius