

FAG

★ 51201

Axial deep groove ball bearing

Schaeffler ID:
0167149890000Axial deep groove ball bearing 512, single
direction, steel sheet metal cage

★ Preferred product

Technical information

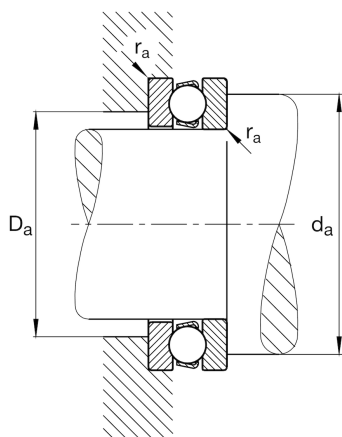
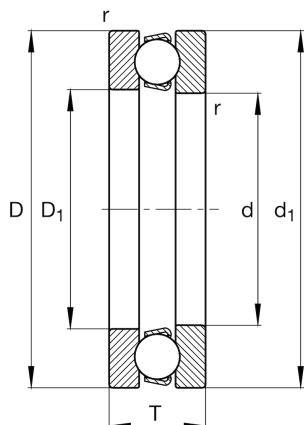

Temperature range

T_{\min}	-30 °C	Operating temperature min.
T_{\max}	150 °C	Operating temperature max.
	30 g	Weight

Main Dimensions & Performance Data

d	12 mm	Bore diameter
D	28 mm	Outside diameter
T	11 mm	Height
C_a	13.200 N	Basic dynamic load rating, axial
C_{0a}	19.000 N	Basic static load rating, axial
C_{ua}	870 N	Fatigue load limit, axial
n_G	11.300 1/min	Limiting speed
n_{gr}	16.900 1/min	Reference speed

Dimensions

r_{\min}	0,6 mm	Minimum chamfer dimension
D_1	14 mm	Bore diameter housing washer
d_1	28 mm	Lip diameter shaft washer

Mounting dimensions

$d_{a \min}$	22 mm	Minimum diameter shaft shoulder
$D_{a \max}$	18 mm	Maximum diameter of housing shoulder
$r_{a \max}$	0,6 mm	Maximum recess radius

Additional information

A	0,002	Minimum load factor
---	-------	---------------------