

FAG

★ 51205

Axial deep groove ball bearing

Schaeffler ID:
0167150200000Axial deep groove ball bearing 512, single
direction, steel sheet metal cage

★ Preferred product

Technical information

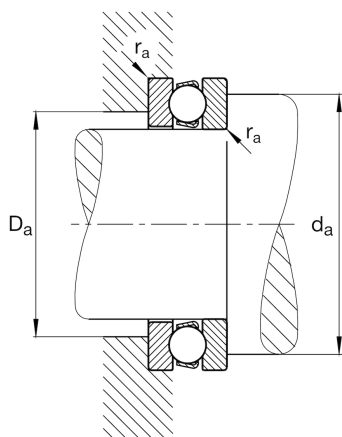
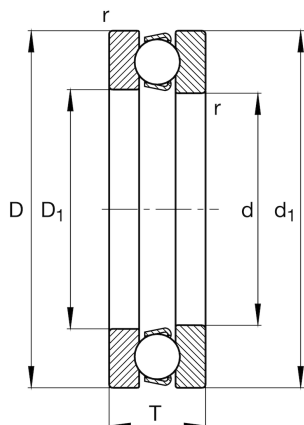

Temperature range

T_{\min}	-30 °C	Operating temperature min.
T_{\max}	150 °C	Operating temperature max.
	0,001 kg	Weight

Main Dimensions & Performance Data

d	25 mm	Bore diameter
D	47 mm	Outside diameter
T	15 mm	Height
C_a	26.500 N	Basic dynamic load rating, axial
C_{0a}	50.000 N	Basic static load rating, axial
C_{ua}	2.280 N	Fatigue load limit, axial
n_G	7.500 1/min	Limiting speed
n_{gr}	9.800 1/min	Reference speed

Dimensions

r_{\min}	0,6 mm	Minimum chamfer dimension
D_1	27 mm	Bore diameter housing washer
d_1	47 mm	Lip diameter shaft washer

Mounting dimensions

$d_{a \min}$	38 mm	Minimum diameter shaft shoulder
$D_{a \max}$	34 mm	Maximum diameter of housing shoulder
$r_{a \max}$	0,6 mm	Maximum recess radius

Additional information

A	0,013	Minimum load factor
---	-------	---------------------