

FAG

★ 51213

Axial deep groove ball bearing

Schaeffler ID:
0167151100000Axial deep groove ball bearing 512, single
direction, steel sheet metal cage

★ Preferred product

Technical information

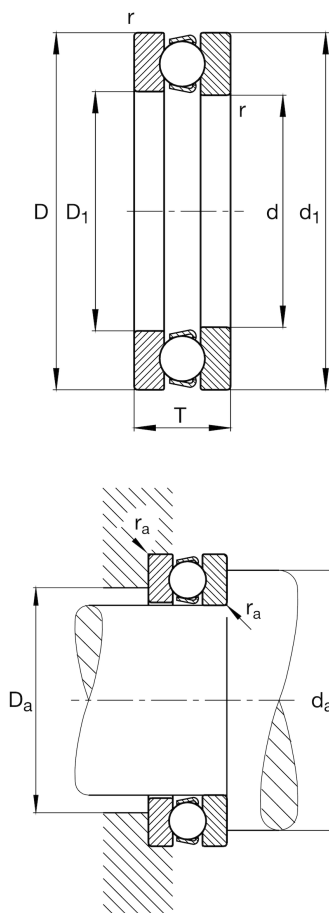

Temperature range

T_{\min}	-30 °C	Operating temperature min.
T_{\max}	150 °C	Operating temperature max.
	0,727 kg	Weight

Main Dimensions & Performance Data

d	65 mm	Bore diameter
D	100 mm	Outside diameter
T	27 mm	Height
C_a	64.000 N	Basic dynamic load rating, axial
C_{0a}	149.000 N	Basic static load rating, axial
C_{ua}	6.800 N	Fatigue load limit, axial
n_G	4.100 1/min	Limiting speed
n_{gr}	4.900 1/min	Reference speed

Dimensions

r_{\min}	1 mm	Minimum chamfer dimension
D_1	67 mm	Bore diameter housing washer
d_1	100 mm	Lip diameter shaft washer

Mounting dimensions

$d_{a \min}$	86 mm	Minimum diameter shaft shoulder
$D_{a \max}$	79 mm	Maximum diameter of housing shoulder
$r_{a \max}$	1 mm	Maximum recess radius

Additional information

A	0,14	Minimum load factor
---	------	---------------------