

FAG

★ 52207

Axial deep groove ball bearing

Schaeffler ID:
0167155430000Axial deep groove ball bearing 522, double
direction, steel sheet metal cage

★ Preferred product

Technical information

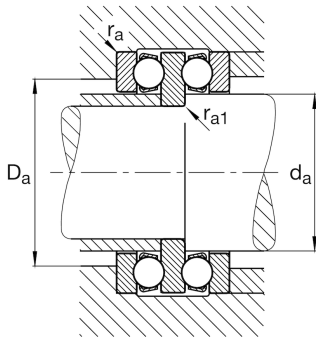
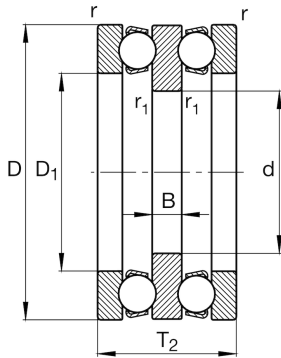

Temperature range

T_{min}	-30 °C	Operating temperature min.
T_{max}	150 °C	Operating temperature max.
	0,405 kg	Weight

Main Dimensions & Performance Data

d	30 mm	Bore diameter
D	62 mm	Outside diameter
T_2	34 mm	Height
C_a	35.500 N	Basic dynamic load rating, axial
C_{0a}	67.000 N	Basic static load rating, axial
C_{ua}	3.100 N	Fatigue load limit, axial
n_G	6.000 1/min	Limiting speed
n_{gr}	7.500 1/min	Reference speed

Dimensions

D_1	37 mm	Bore diameter housing washer
B	8 mm	Height shaft washer
r_{min}	1 mm	Minimum chamfer dimension
$r_{1 min}$	0,3 mm	Minimum chamfer dimension

Mounting dimensions

$d_{a max}$	35 mm	Maximum mounting dimension shaft
$D_{a max}$	46 mm	Maximum diameter of housing shoulder
$r_{a max}$	1 mm	Maximum recess radius
$r_{a1 max}$	0,3 mm	Maximum recess radius

Additional information

A	0,028	Minimum load factor
---	-------	---------------------