

FAG

★ 4207-BB-TVH

Deep groove ball bearing

Schaeffler ID:
0219434780000Deep groove ball bearing 42...BB-TVH,
double row, plastic cage

★ Preferred product

Technical information

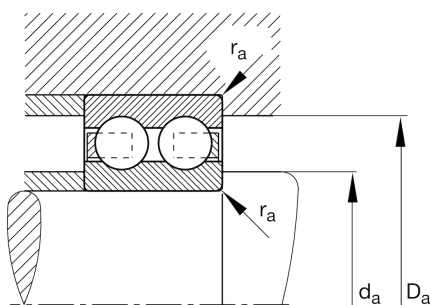
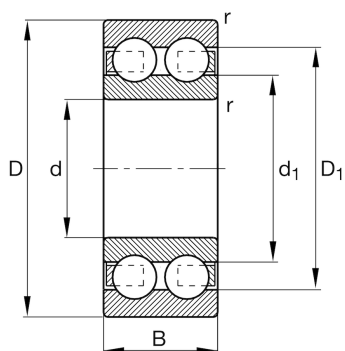

Temperature range

T_{\min}	-20 °C	Operating temperature min.
T_{\max}	120 °C	Operating temperature max.
	0,4 kg	Weight

Main Dimensions & Performance Data

d	35 mm	Bore diameter
D	72 mm	Outside diameter
B	23 mm	Width
C_r	39.500 N	Basic dynamic load rating, radial
C_{0r}	30.000 N	Basic static load rating, radial
C_{ur}	1.570 N	Fatigue load limit, radial
n_G	7.900 1/min	Limiting speed
n_{gr}	8.700 1/min	Reference speed

Dimensions

r_{\min}	1,1 mm	Minimum chamfer dimension
D_1	60,4 mm	Shoulder diameter outer ring
d_1	46,3 mm	Shoulder diameter inner ring

Mounting dimensions

$d_{a \min}$	42 mm	Minimum diameter shaft shoulder
$D_{a \max}$	65 mm	Maximum diameter of housing shoulder
$r_{a \max}$	1 mm	Maximum fillet radius

Calculation factors

f_0	14,1	Calculation factor
-------	------	--------------------