

FAG

★ 61820-2RZ-Y

Deep groove ball bearing

Schaeffler ID:
0807218690000Deep groove ball bearing 618...-2RZ-Y,
single row, shields, brass sheet metal cage

★ Preferred product

Technical information

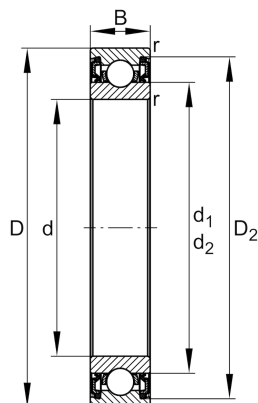
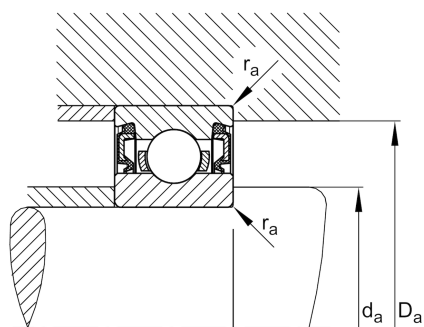

Temperature range

T_{\min}	-20 °C	Operating temperature min.
T_{\max}	110 °C	Operating temperature max.
	0,003 kg	Weight

Main Dimensions & Performance Data

d	100 mm	Bore diameter
D	125 mm	Outside diameter
B	13 mm	Width
C_r	21.300 N	Basic dynamic load rating, radial
C_{0r}	22.100 N	Basic static load rating, radial
C_{ur}	1.250 N	Fatigue load limit, radial
n_G	6.300 1/min	Limiting speed
n_{gr}	4.150 1/min	Reference speed

Dimensions

r_{\min}	1 mm	Minimum chamfer dimension
D_2	119,2 mm	Caliber diameter outer ring
d_1	108,2 mm	Shoulder diameter inner ring

Mounting dimensions

$d_{a\min}$	104,6 mm	Minimum diameter shaft shoulder
$D_{a\max}$	120,4 mm	Maximum diameter of housing shoulder
$r_{a\max}$	1 mm	Maximum fillet radius

Calculation factors

f_0	16	Calculation factor
-------	----	--------------------