

FAG

## ★ 6201-C-2HRS

Deep groove ball bearing

Schaeffler ID:  
0594888750000Deep groove ball bearing 62...-C-2HRS,  
single row, Generation C, seals, steel  
sheet metal cage

★ Preferred product

## Technical information

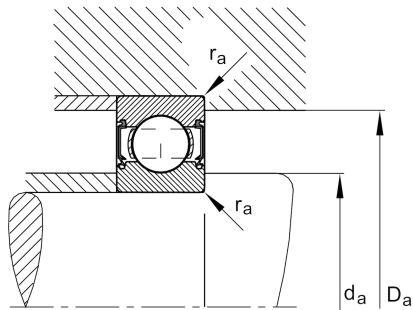
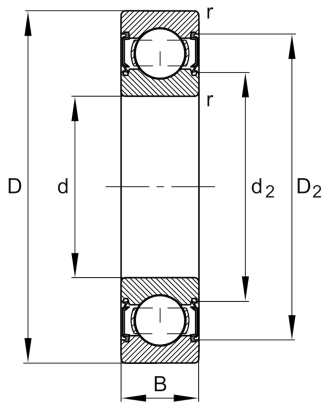

## Temperature range

$T_{\min}$	-20 °C	Operating temperature min.
$T_{\max}$	110 °C	Operating temperature max.
	0,036 kg	Weight

## Main Dimensions &amp; Performance Data

d	12 mm	Bore diameter
D	32 mm	Outside diameter
B	10 mm	Width
$C_r$	8.000 N	Basic dynamic load rating, radial
$C_{0r}$	3.100 N	Basic static load rating, radial
$C_{ur}$	213 N	Fatigue load limit, radial
$n_G$	22.500 1/min	Limiting speed

## Dimensions

$r_{\min}$	0,6 mm	Minimum chamfer dimension
$D_2$	27,9 mm	Caliber diameter outer ring
$d_2$	17,2 mm	Caliber diameter inner ring

## Mounting dimensions

$d_{a\min}$	16,2 mm	Minimum diameter shaft shoulder
$D_{a\max}$	27,8 mm	Maximum diameter of housing shoulder
$r_{a\max}$	0,6 mm	Maximum fillet radius

## Calculation factors

$f_0$	12,3	Calculation factor
-------	------	--------------------