

FAG

★ 6309-C-2HRS

Deep groove ball bearing

Schaeffler ID:
0816674770000Deep groove ball bearing 63...-C-2HRS,
single row, Generation C, seals, steel
sheet metal cage

★ Preferred product

Technical information

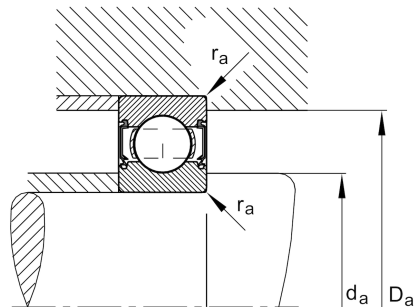
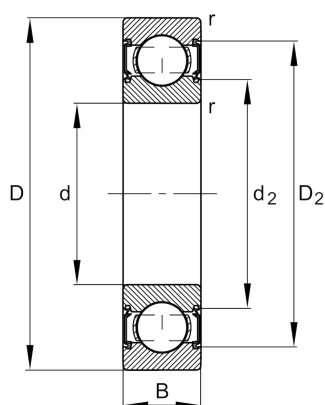

Temperature range

T_{\min}	-20 °C	Operating temperature min.
T_{\max}	110 °C	Operating temperature max.
	0,834 kg	Weight

Main Dimensions & Performance Data

d	45 mm	Bore diameter
D	100 mm	Outside diameter
B	25 mm	Width
C_r	58.000 N	Basic dynamic load rating, radial
C_{0r}	31.500 N	Basic static load rating, radial
C_{ur}	2.200 N	Fatigue load limit, radial
n_G	6.400 1/min	Limiting speed

Dimensions

r_{\min}	1,5 mm	Minimum chamfer dimension
D_2	86,4 mm	Caliber diameter outer ring
d_2	60,3 mm	Caliber diameter inner ring

Mounting dimensions

$d_{a\min}$	54 mm	Minimum diameter shaft shoulder
$D_{a\max}$	91 mm	Maximum diameter of housing shoulder
$r_{a\max}$	1,5 mm	Maximum fillet radius

Calculation factors

f_0	12,9	Calculation factor
-------	------	--------------------