

FAG

★ 6312-C-2Z

Deep groove ball bearing

Schaeffler ID:
0819123740000

★ Preferred product

Deep groove ball bearing 63...-C-2Z, single row, Generation C, shields, steel sheet metal cage

Technical information

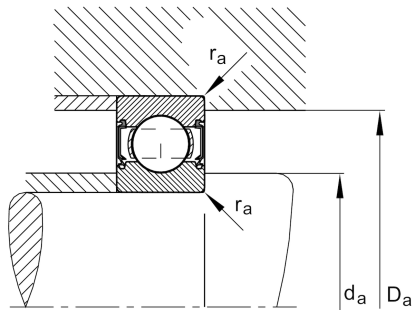
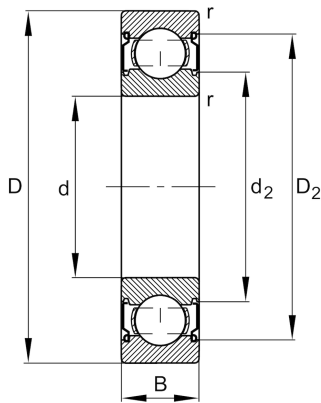

Temperature range

T_{\min}	-20 °C	Operating temperature min.
T_{\max}	120 °C	Operating temperature max.
	1,697 kg	Weight

Main Dimensions & Performance Data

d	60 mm	Bore diameter
D	130 mm	Outside diameter
B	31 mm	Width
C_r	89.000 N	Basic dynamic load rating, radial
C_{0r}	52.000 N	Basic static load rating, radial
C_{ur}	3.600 N	Fatigue load limit, radial
n_G	6.700 1/min	Limiting speed
n_{gr}	7.400 1/min	Reference speed

Dimensions

r_{\min}	2,1 mm	Minimum chamfer dimension
D_2	112,1 mm	Caliber diameter outer ring
d_2	79,6 mm	Caliber diameter inner ring

Mounting dimensions

$d_{a\min}$	72 mm	Minimum diameter shaft shoulder
$D_{a\max}$	118 mm	Maximum diameter of housing shoulder
$r_{a\max}$	2,1 mm	Maximum fillet radius

Calculation factors

f_0	13,2	Calculation factor
-------	------	--------------------