

FAG

★ QJ208-XL-MPA

Four-point contact bearing

Schaeffler ID:
0167422490000Four point contact bearing QJ2..-XL-MPA,
X-life, solid brass cage

★ Preferred product

X-life

Technical information

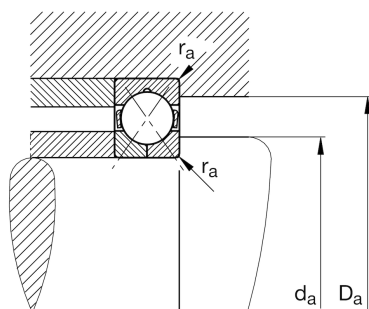
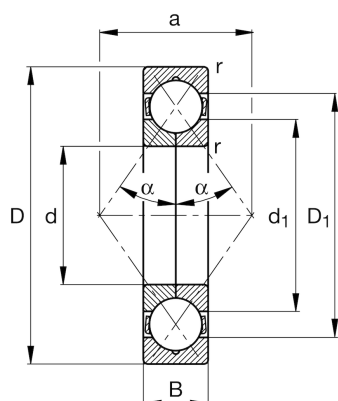

Temperature range

T_{min}	-30 °C	Operating temperature min.
T_{max}	150 °C	Operating temperature max.
	0,004 kg	Weight

Main Dimensions & Performance Data

d	40 mm	Bore diameter
D	80 mm	Outside diameter
B	18 mm	Width
C_r	58.000 N	Basic dynamic load rating, radial
C_{0r}	46.500 N	Basic static load rating, radial
C_{ur}	3.250 N	Fatigue load limit, radial
n_G	17.500 1/min	Limiting speed
n_{gr}	7.500 1/min	Reference speed

Dimensions

r_{min}	1,1 mm	Minimum chamfer dimension
D_1	66,8 mm	Shoulder diameter outer ring
d_1	53,7 mm	Shoulder diameter inner ring
a	42 mm	Distance between the apexes of the pressure cones
α	35 °	Contact angle

Mounting dimensions

$d_{a min}$	47 mm	Minimum diameter shaft shoulder
$D_{a max}$	73 mm	Maximum diameter of housing shoulder
$r_{a max}$	1 mm	Maximum fillet radius