

FAG

★ QJ211-XL-MPA

Four-point contact bearing

Schaeffler ID:
0192605120000Four point contact bearing QJ2..-XL-MPA,
X-life, solid brass cage

★ Preferred product

X-life

Technical information

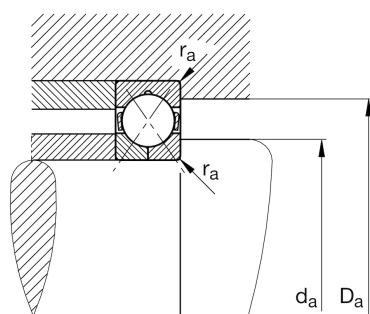

Temperature range

T_{min}	-30 °C	Operating temperature min.
T_{max}	150 °C	Operating temperature max.
	0,75 kg	Weight

Main Dimensions & Performance Data

d	55 mm	Bore diameter
D	100 mm	Outside diameter
B	21 mm	Width
C_r	77.000 N	Basic dynamic load rating, radial
C_{0r}	71.000 N	Basic static load rating, radial
C_{ur}	5.000 N	Fatigue load limit, radial
n_G	13.600 1/min	Limiting speed
n_{gr}	5.900 1/min	Reference speed

Dimensions

r_{min}	1,5 mm	Minimum chamfer dimension
D_1	84,7 mm	Shoulder diameter outer ring
d_1	70,4 mm	Shoulder diameter inner ring
a	54 mm	Distance between the apexes of the pressure cones
α	35 °	Contact angle

Mounting dimensions

$d_{a min}$	64 mm	Minimum diameter shaft shoulder
$D_{a max}$	91 mm	Maximum diameter of housing shoulder
$r_{a max}$	1,5 mm	Maximum fillet radius