

FAG

## ★ QJ211-XL-TVP

Four-point contact bearing

Schaeffler ID:  
0192605630000Four point contact bearing QJ2..-XL-TVP,  
X-life, plastic cage

★ Preferred product

X-life

## Technical information

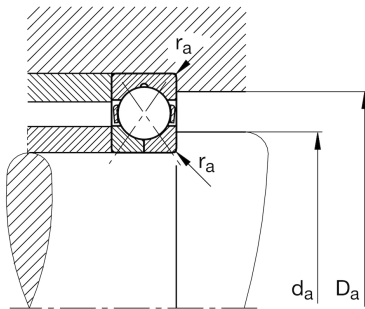
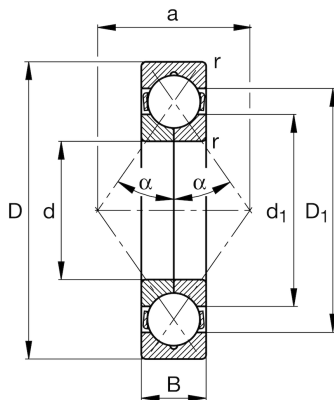

## Temperature range

$T_{min}$	-30 °C	Operating temperature min.
$T_{max}$	120 °C	Operating temperature max.
	0,66 kg	Weight

## Main Dimensions &amp; Performance Data

d	55 mm	Bore diameter
D	100 mm	Outside diameter
B	21 mm	Width
$C_r$	81.000 N	Basic dynamic load rating, radial
$C_{0r}$	76.000 N	Basic static load rating, radial
$C_{ur}$	5.300 N	Fatigue load limit, radial
$n_G$	9.100 1/min	Limiting speed
$n_{gr}$	5.800 1/min	Reference speed

## Dimensions

$r_{min}$	1,5 mm	Minimum chamfer dimension
$D_1$	84,7 mm	Shoulder diameter outer ring
$d_1$	70,4 mm	Shoulder diameter inner ring
a	54 mm	Distance between the apexes of the pressure cones
$\alpha$	35 °	Contact angle

## Mounting dimensions

$d_{a min}$	64 mm	Minimum diameter shaft shoulder
$D_{a max}$	91 mm	Maximum diameter of housing shoulder
$r_{a max}$	1,5 mm	Maximum fillet radius