

FAG

## ★ QJ305-XL-MPA

Four-point contact bearing

Schaeffler ID:  
0167424270000Four point contact bearing QJ3..-XL-MPA,  
X-life, solid brass cage

★ Preferred product

X-life

## Technical information

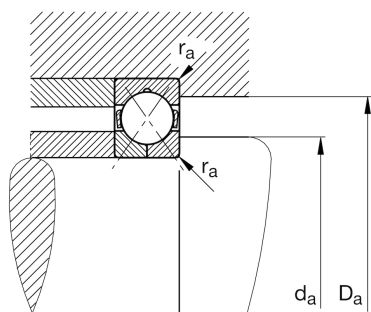
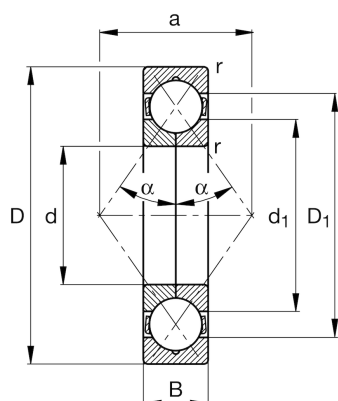

## Temperature range

$T_{min}$	-30 °C	Operating temperature min.
$T_{max}$	150 °C	Operating temperature max.
	0,273 kg	Weight

## Main Dimensions &amp; Performance Data

d	25 mm	Bore diameter
D	62 mm	Outside diameter
B	17 mm	Width
$C_r$	43.500 N	Basic dynamic load rating, radial
$C_{0r}$	28.500 N	Basic static load rating, radial
$C_{ur}$	1.960 N	Fatigue load limit, radial
$n_G$	23.300 1/min	Limiting speed
$n_{gr}$	9.000 1/min	Reference speed

## Dimensions

$r_{min}$	1,1 mm	Minimum chamfer dimension
$D_1$	49,5 mm	Shoulder diameter outer ring
$d_1$	37,5 mm	Shoulder diameter inner ring
a	31 mm	Distance between the apexes of the pressure cones
$\alpha$	35 °	Contact angle

## Mounting dimensions

$d_{a min}$	32 mm	Minimum diameter shaft shoulder
$D_{a max}$	55 mm	Maximum diameter of housing shoulder
$r_{a max}$	1 mm	Maximum fillet radius