

FAG

★ QJ308-XL-TVP

Four-point contact bearing

Schaeffler ID:
0167425080000Four point contact bearing QJ3..-XL-TVP,
X-life, plastic cage

★ Preferred product

X-life

Technical information

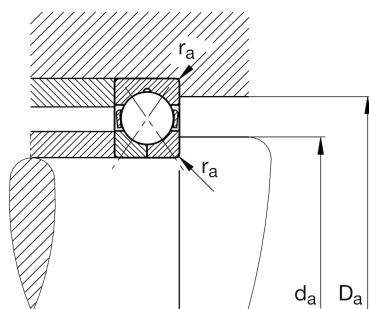
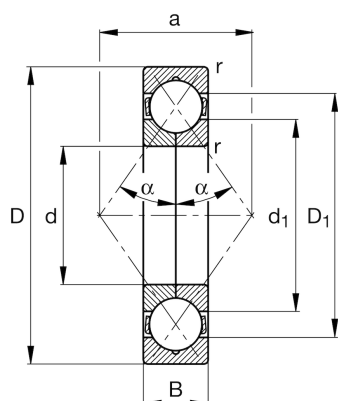

Temperature range

T_{min}	-30 °C	Operating temperature min.
T_{max}	120 °C	Operating temperature max.
	0,675 kg	Weight

Main Dimensions & Performance Data

d	40 mm	Bore diameter
D	90 mm	Outside diameter
B	23 mm	Width
C_r	90.000 N	Basic dynamic load rating, radial
C_{0r}	69.000 N	Basic static load rating, radial
C_{ur}	4.750 N	Fatigue load limit, radial
n_G	10.200 1/min	Limiting speed
n_{gr}	6.200 1/min	Reference speed

Dimensions

r_{min}	1,5 mm	Minimum chamfer dimension
D_1	73,4 mm	Shoulder diameter outer ring
d_1	56,7 mm	Shoulder diameter inner ring
a	46 mm	Distance between the apexes of the pressure cones
α	35 °	Contact angle

Mounting dimensions

$d_{a min}$	49 mm	Minimum diameter shaft shoulder
$D_{a max}$	81 mm	Maximum diameter of housing shoulder
$r_{a max}$	1,5 mm	Maximum fillet radius